

SCANIA POWER GENERATION ENGINE: CHINA STAGE IV

# 13-LITRE ENGINE

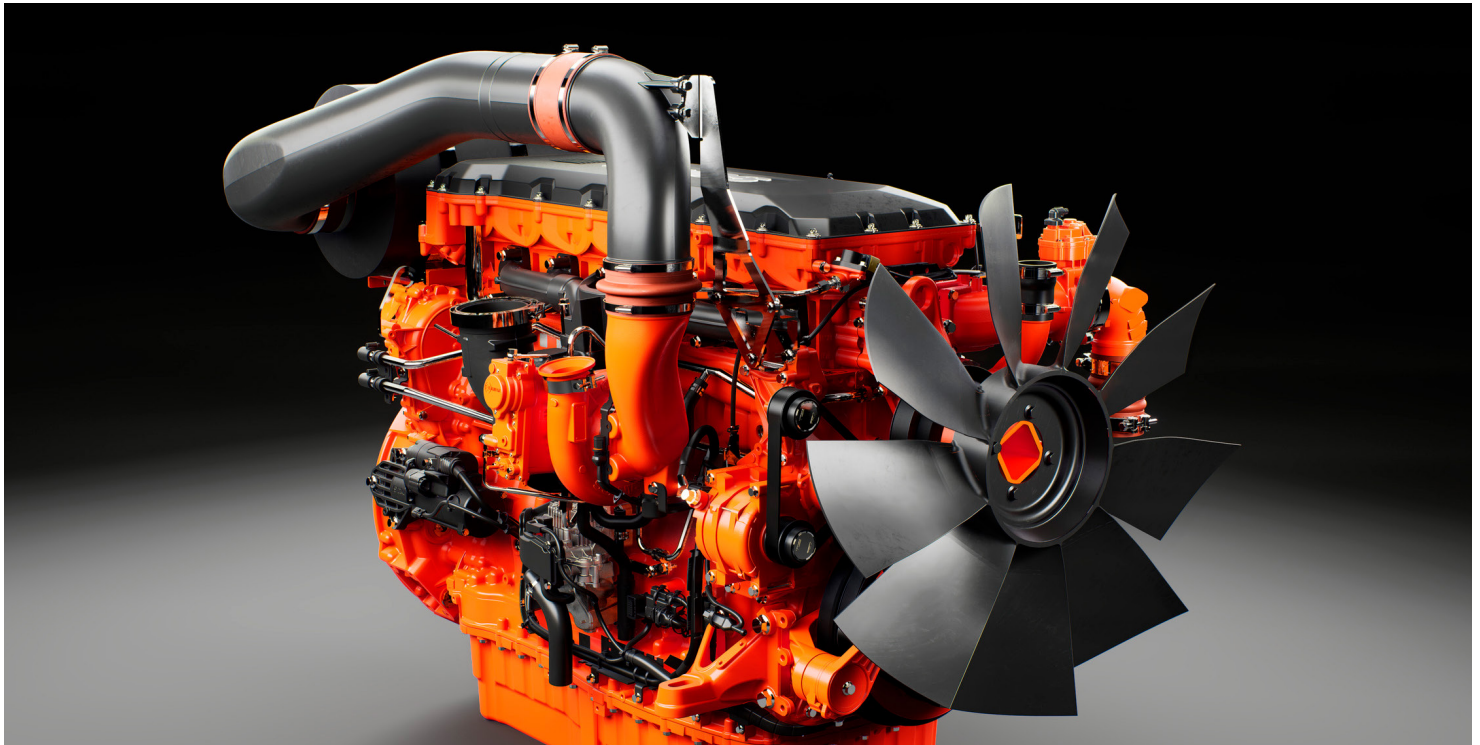

## Engine description

DC13 506A. 300/300 kVA (269/275 kW)

<b>Engine speed</b>	1,500/1,800 rpm
<b>Emission compliance</b>	China Stage IV
<b>Rating</b>	PRP
<b>No of cylinders</b>	6 in-line
<b>Working principle</b>	4-stroke
<b>Displacement</b>	12.7 litres
<b>Weight</b>	1,074 kg (excluding oil and coolant)
<b>Oil capacity</b>	28-38 litres (standard oil sump)
<b>Electrical system</b>	1-pole 24 V DC

Scania's emission compliant power generation engines are based on the next generation engine platform, which provides superior economy and reliability. The engines offer easy installation for the producer of the equipment as well as easy access to daily checks and service for the operator. The engines can be fitted with many accessories such as air cleaners, exhaust fittings and cooling packages to suit a variety of installations.

Scania's next generation inline engines are equipped with a Scania-developed Extra High Pressure fuel injection system based on common rail technology, and a turbocharger optimized for operation in combination with the exhaust gas aftertreatment system. Together with Scania's Engine Management System, the result is an engine that fulfils the strictest exhaust gas emission requirements while it delivers low fuel consumption and high power.

### Standard equipment

- Variable Geometry Turbocharger (VGT)
- Dual Overhead Camshaft (DOHC)
- Saver ring in cylinder liner
- Aluminum flywheel housing, SAE 1 flange
- Flywheel SAE 14
- Front-mounted engine brackets
- Open crankcase ventilation
- Electric air intake throttle
- Front- and rear-mounted lifting eyes
- Extra High Pressure fuel injection system, XPI
- Engine-mounted fuel filter and extra pre-filter with water separator, for separate mounting
- Deep front oil sump
- Magnetic drain plug for oil draining
- Oil filter, full flow
- Oil cooler, integrated in cylinder block
- Oil filler and dipstick, short, left-hand side, in ladder frame
- Scania Engine Management System, EMS
- Starter motor, 1-pole, 5.5 kW (EMS-controlled)
- Alternator, 1-pole 100 A (EMS-controlled)
- Distributed exhaust gas aftertreatment system

This specification may be revised without notice.

## Dimensions

<b>A</b> Overall length	1,401
<b>B</b> Centre of crankshaft to bottom	370
<b>C</b> Centre of crankshaft to top	691
<b>D</b> Centre of crankshaft to right-hand side	498
<b>E</b> Centre of crankshaft to left-hand side	513

All dimensions indicated in mm.

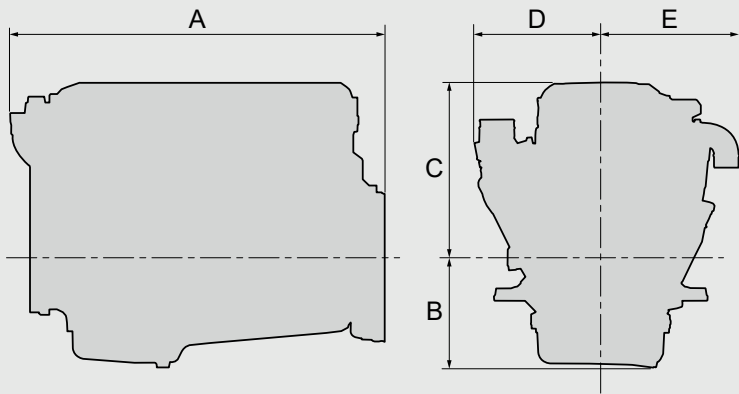

## Technical data

	1,500 rpm (50 Hz)	1,800 rpm (60 Hz)	Unit
Gross power	300	300	kVA
	269	275	kW
Gross torque	1,713	1,459	Nm
Fuel consumption			
at full load	183	188	g/kWh
at 3/4 load	185	192	g/kWh
at 1/2 load	196	206	g/kWh
at 1/4 load	230	265	g/kWh
Reductant consumption at full load	23	22	g/kWh
Heat rejection			
to coolant	92	94	kW
to exhaust gas	164	176	kW
to charge air	30	39	kW
to surrounding air	23	24	kW
Air consumption	22	27	kg/min
Air temperature			
upstream of charge air cooler	131	136	°C
downstream of charge air cooler	50	50	°C
Pressure in intake manifold	1.24	1.26	bar
Pressure drop in charge air cooler	0.06	0.08	bar
Exhaust gas flow	23	28	kg/min
Exhaust gas temperature	422	384	°C

**PRP - Prime power:** For continuous operation and unlimited yearly operating time at varying load. Max. mean load factor of 70% of rated power over 24 h of operation. 1 hour/12-hour period of overload to 110% load. Max. 25 h accumulated service time above 100% load per year.

## SCANIA INDUSTRIAL AND POWER GENERATION ENGINES

# EXHAUST GAS AFTERTREATMENT SYSTEM

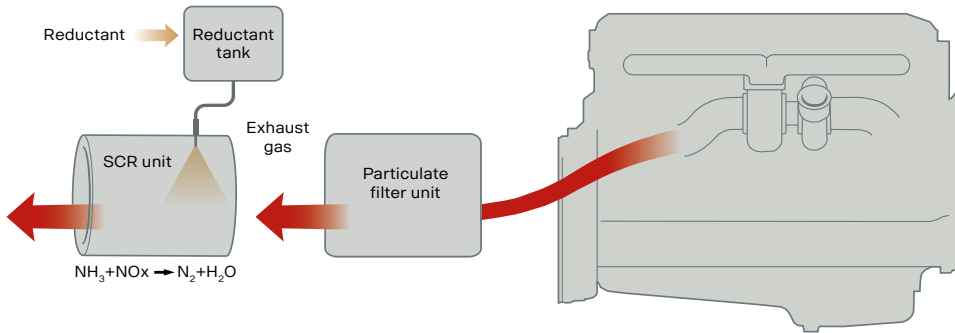

The emissions of particulate matter are filtered through a ceramic structure, that only allows particles smaller than a defined size to pass. When the filter is filled with soot particles to a specific amount, it is regenerated automatically.

SCR technology: A chemical process is started when reductant, a urea and water mixture, is injected into the exhaust gas stream. During injection, the water evaporates, and the urea breaks down to form ammonia. The ammonia then reacts with the nitrogen oxide gases in the catalytic converter and forms harmless products such as nitrogen gas and water.

SCR (Selective Catalytic Reduction) technology, in combination with a particulate filter and an oxidation catalytic converter (integrated in the particulate filter unit), is used on Scania's emission compliant engines to reduce the NO<sub>x</sub> and particle content in the exhaust gases in the best possible way.

## Mechanical system

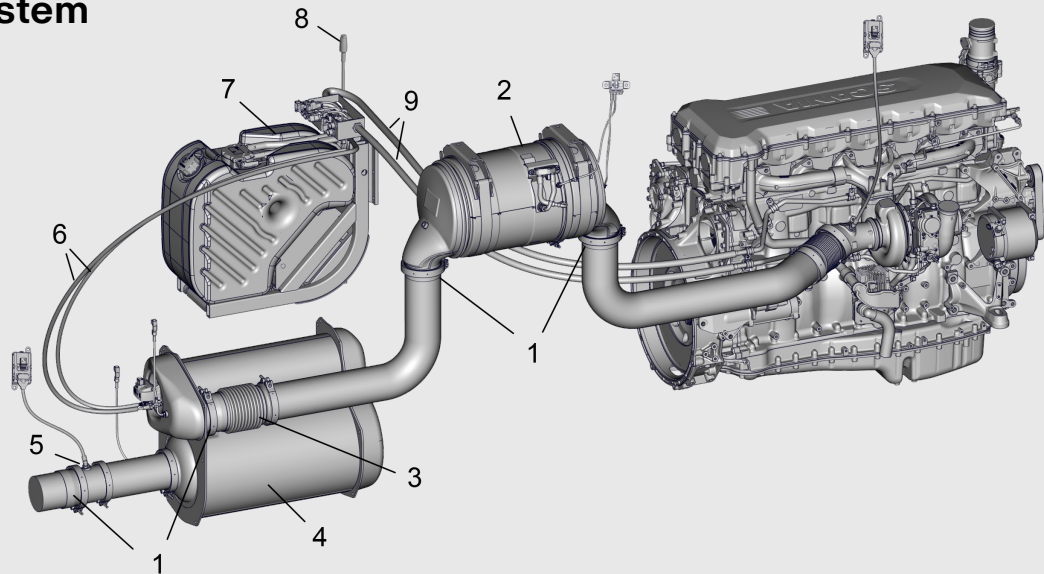

	Standard	Optional
1 Exhaust flanges	-	Ø114, 130, 155 mm
2 Particulate filter unit	with 90° outlet	with straight outlet
3 Exhaust bellows	-	1 to 3 pieces
4 SCR unit	without outlet bend	with 90° outlet bend
5 Outlet flange for NO <sub>x</sub> sensor*	length 323 mm	length 100 mm, weld union, without
6 Reductant hoses	2.5 m	4 m, 5 m, 6.5 m
7 Reductant tank	38 l	45 l, 60 l, 63 l, 70 l
8 Reductant bleed hose	0.8 m	3.3 m
9 Coolant hoses for heating of tank and pump	-	-

\* The NO<sub>x</sub> sensor must be positioned at least 300 mm downstream of the SCR unit outlet.  
Additional reductant storage tanks including pump are also available in the same sizes as the standard reductant tank.

## Electrical system

- 1 NOx sensor upstream with control unit
- 2 Temperature sensors with control unit
- 3 Differential pressure sensor
- 4 Temperature sensor
- 5 Reductant doser
- 6 Temperature sensor\*
- 7 NOx sensor downstream with control unit
- 8 Electric interface to exhaust emission control system

All components are standard equipment. Standard cable length is 3.0 m, optional 4.5 m, 6 m (9 m). Differential pressure sensor is also available for remote mounting.

\* Only valid for US Tier 4f compliant engines.

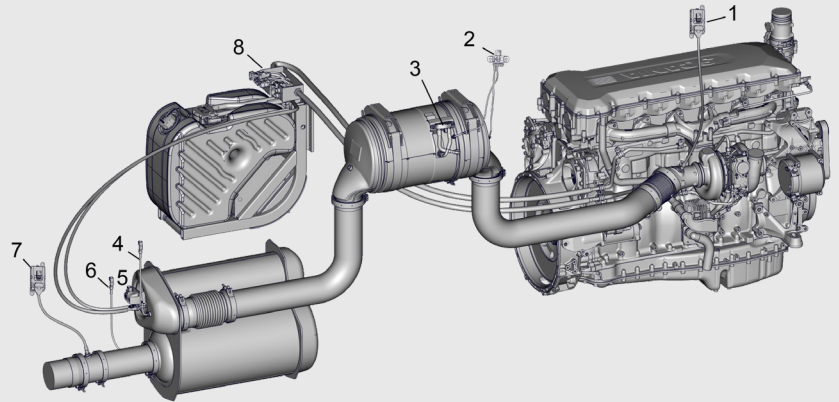

## Particulate filter unit

Engine	L1	L2	Weight
DC11A	603 mm	747 mm	27 kg
DC13A	679 mm	823 mm	31 kg

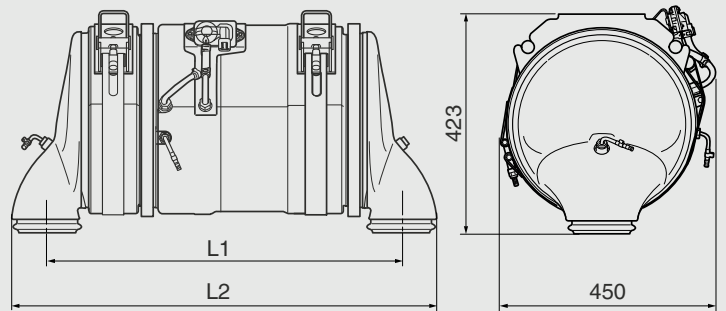

## SCR unit

Engine	L1	L2	Weight
DC11A	518 mm	764 mm	65 kg
DC13A	595 mm	841 mm	73 kg

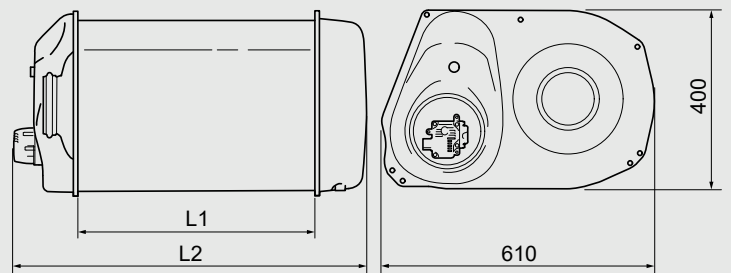

## Reductant tank

### Available sizes

Filling volume	Total volume	Weight
38 litres	50 litres	53 kg
45 litres	60 litres	44 kg
60 litres	75 litres	56 kg
63 litres	80 litres	50 kg
70 litres	90 litres	54 kg

